

# KL Series **II**

# KL Series II

1.2mm | 1.5mm | 1.8mm | 2.5mm

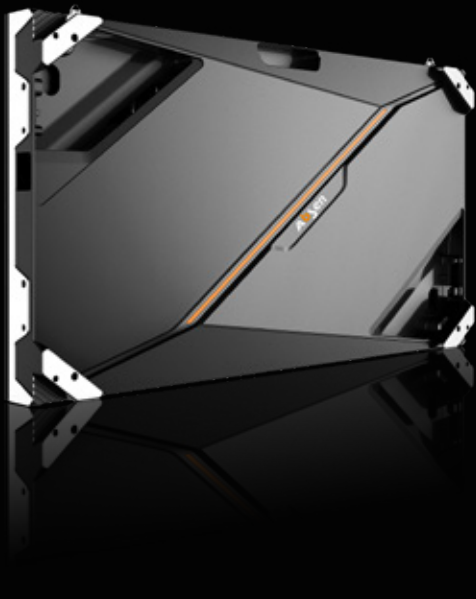

**16:9**

Golden ratio



**HFR+**

High frame rate mode



**800nits**

Maximum brightness



**X/Y/Z axis**

Six-direction alignment



**Fine Adjustment**

Grayscale improvement technology



**Color Precision**

Color management technology



**3840Hz**

High refresh rate



**Floating connectors**

Fast installation and maintenance



# For all commercial display applications



Control rooms



Retail, shopping malls

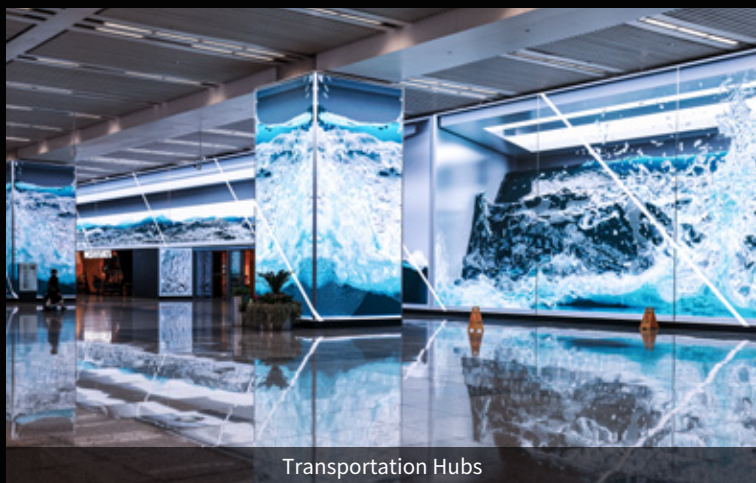

Transportation Hubs

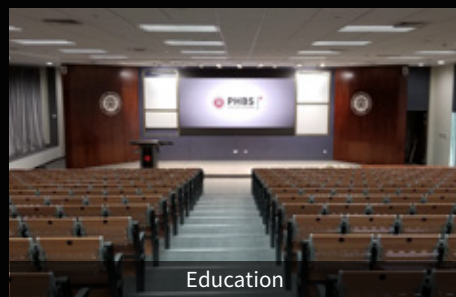

Education

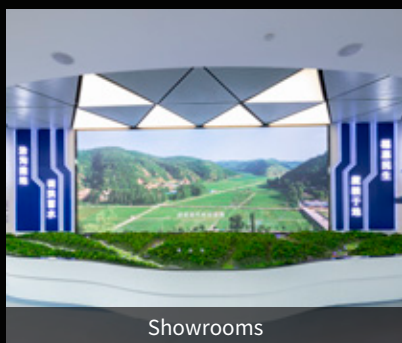

Showrooms



Enterprises



Conference Rooms

## Ready-to-use panel with superior quality

Adopting the closed design, the panel contains high-quality PFC\* power supply unit, receiving card and other components. Delivered in the form of ready-to-use panel, product quality is more guaranteed.

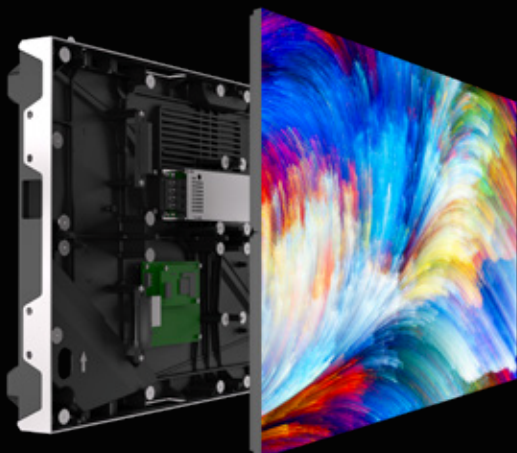

High-quality PFC power supply unit

Power factor  $\cos\phi \geq 0.95$ , power efficiency  $\geq 88\%$



Fine die-casting aluminum cabinet



High-performance receiving card



Magnets with strong attraction force

## Innovative floating connectors with patent

Absen's new innovative floating connector\* realizes cable-free connection between the module and panel, making installation and maintenance more convenient and efficient.

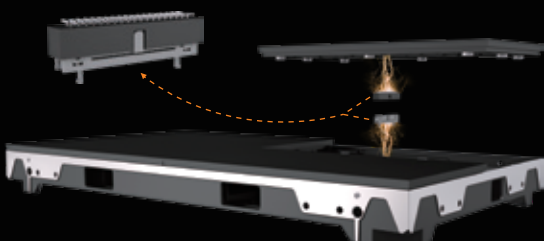

Invention patent & design patent\*



Good location fault tolerance



Anti-torsion, anti-collision, anti-vibration

\*PFC means power factor correction, which is a technology to improve the power factor of electrical equipment to improve power utilization.

\*Absen has applied for relevant invention and design patents

## Golden ratio brings better visual comfort

Based on ergonomic research, the panel adopts the golden ratio of 16:9 to enhance viewing comfort. It is also more suitable for playing mainstream videos.

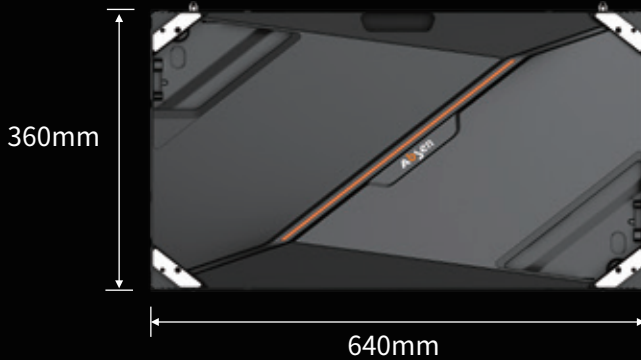

# 16:9

Panel size

The optimal aspect ratio for viewing  
Mainstream video aspect ratio

## Easily enjoy 8K vision display

72 panels can be spliced into a 16:9 screen to quickly achieve a 2K, 4K or even 8K display, making it especially suitable for use in places such as studios, command centers and conference rooms.

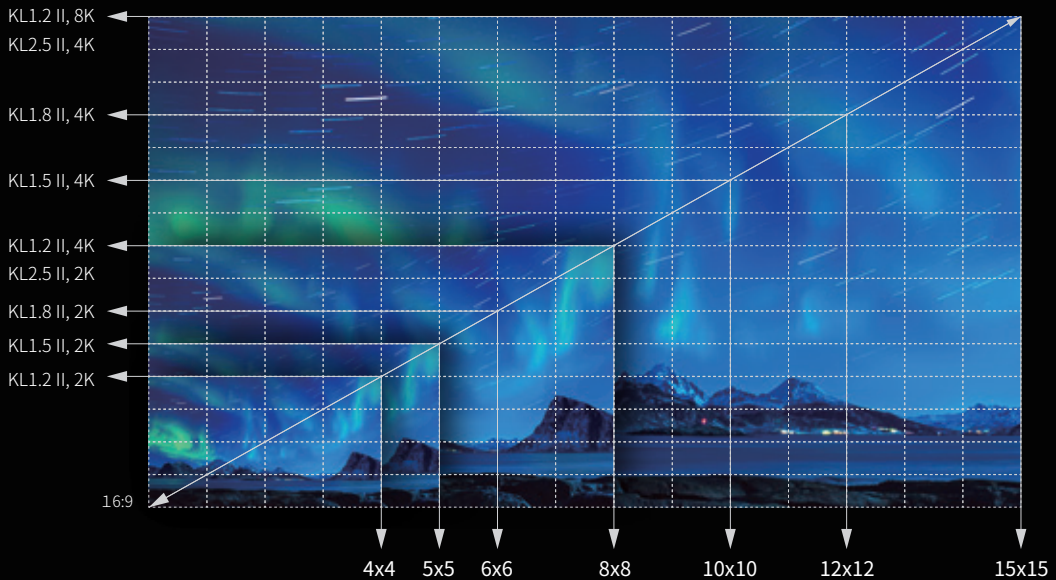



## Fine Adjustment grayscale improvement technology

The grayscale performance is increased by four times, making the grayscale changes more naturally. Even under low brightness, it can perfectly display details even in the dark parts of the picture.



Fine grayscale, details visible in dark parts



Low grayscale, details lost in dark parts

## Color Precision management technology

Intelligent adjustment is made through Color Precision management technology to match the color gamut range of the display with the source image. Highly reproduce natural scenes and achieve high-fidelity colors.



Original image



No color management, with color deviation

**With color management, no color deviation**

## HFR+ mode for capturing the best moments

Support HFR+ mode (120Hz high frame rate)\*, smoothly display high-speed, quick-changing content and enhance visual fluency, making it especially suitable for playing high-speed motion pictures and 3D pictures.



\*Only KL1.5 II, KL1.8 II and KL2.5 II support HFR+ mode



# Ultra-low latency enables real-time image display

Reduces delays in transmission of video sources, synchronizes the display of real-time images and helps achieve live broadcasting with ease.



Sync to KL II series  
Low latency

Sync to other displays  
Significant latency

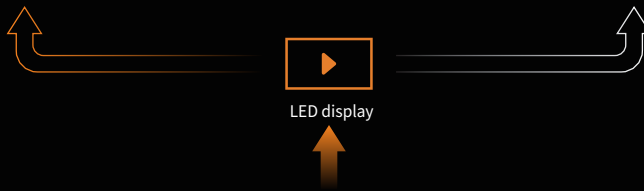

Live broadcast of transmitted computer images

## Record exciting moments as you like

The brightness can reach up to 800nits, which greatly reduces the influence of ambient light on the display effect. Using PWM LED driver IC, the refresh rate is as high as 3840Hz, and there is no scan line when taking pictures.



Photo taken without scan lines

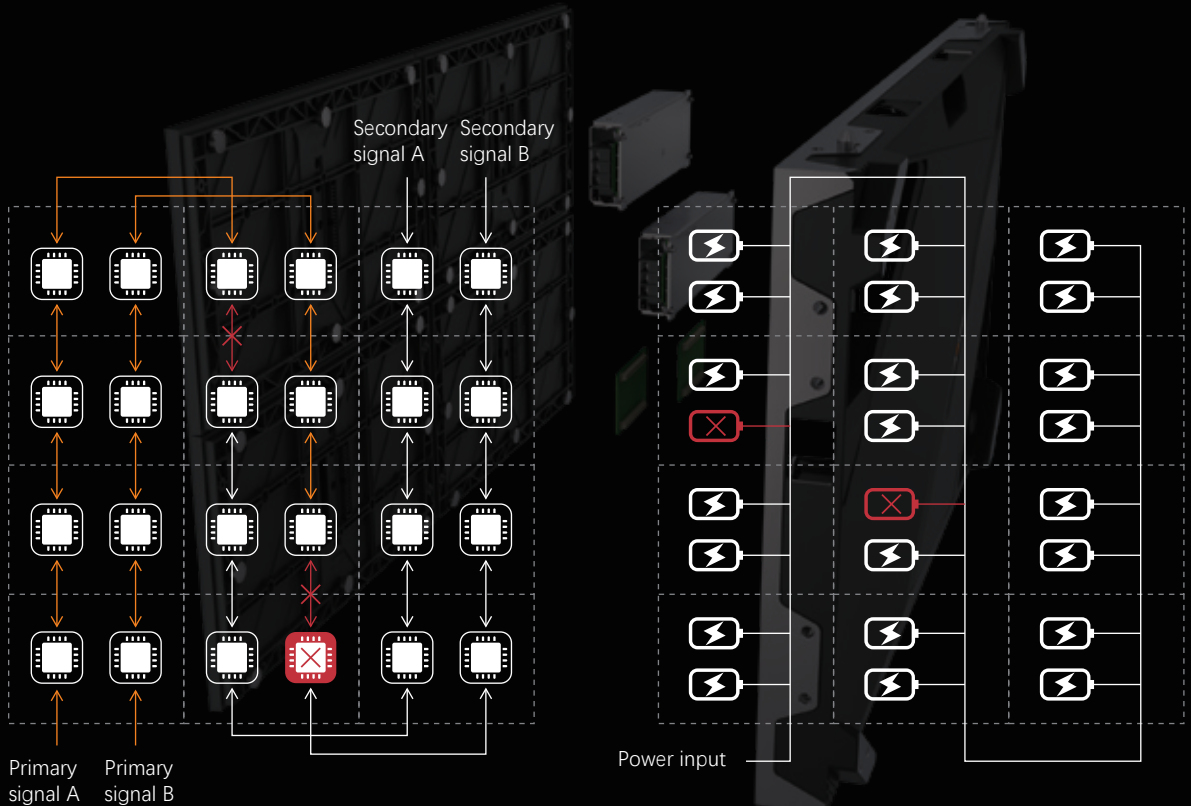

Photo taken with scan lines

## Power and data redundancy

Provides optional dual backup version to ensure uninterrupted power supply and signal, so as to realize continuous transmission of information.

This function is especially suitable for use in places such as control rooms and studios.



**Dual-channel signal loop backup, greatly improves fault tolerance and reliability**

(Single channel receives primary and secondary signal at the same time)

**When the panel's single PSU is not working, the power supply is still on**



## Multiple installation methods

The KL II Series supports hanging, wall mounting and stacking installation, etc. Hidden wiring design is adopted to make the installation more tidy. It supports six-direction alignment to improve flatness of the screen.

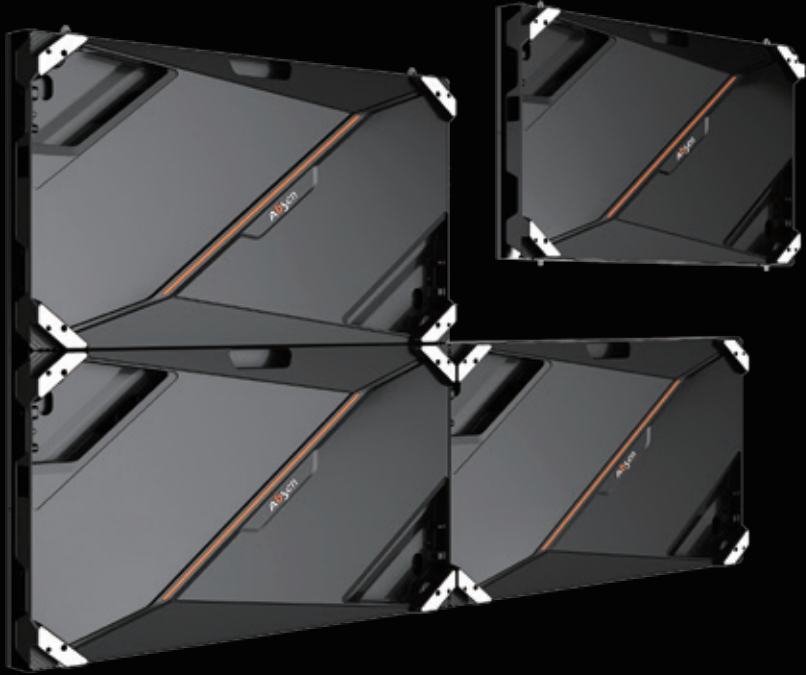

Stacking installation

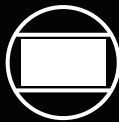

Wall-mounting installation



Hanging installation



L-shaped splicing\*



Hidden wiring design



Anti-collision design



Quick plug-in/out



X/Y/Z axis alignment

\*Only for customized version

## Standard elegant accessories

Provide standard hanging bar and backing strip accessories to make installation easier.  
Provide ultra-thin trim pieces solution to enhance aesthetic feeling in all directions.



- 640mm/1280mm hanging bar



- 2-in-1/ 3-in-1 backing strip



- Ultra-thin trim pieces

## Easy and convenient front maintenance

Support front maintenance of module, receiving card and power supply unit.  
No need to build a dedicated maintenance channel, thereby saving installation space.



Module



Receiving card



PSU



Dedicated front maintenance tool



# Standardized quality control

It is manufactured in Absen's own factory through a standardized production process, and has obtained multiple certifications, allowing customers to use it without any worries.



## Standardized manufacturing process

Every step of the production process is strictly managed to ensure product quality

## Strict quality control

18 monitoring procedures  
29 operating procedures  
33 recording procedures  
2,285 inspections and tests

## Multiple certifications obtained, legal and compliant

Certified through CE, ETL, FCC, CCC, China Energy Conservation Certification, etc.  
Passed performance/ blue light hazard/ photobiology test, etc.,  
which are recognized by CNAS accredited institution

# Professional service, best experience

Absen has built up a global network , able to provide prompt and professional local services.

## Absen service ability



### Comprehensive support

Enjoy 2-year warranty, support up to 3-year extended warranty, lifetime maintenance, and enjoy 10+ items of professional service solutions to help you solve problems



### Global coverage

400+ Absen certified partners, 2,600+ Absen certified engineers, covering most of the global market, the global service network is continuing to expand vigorously



### Multiple service channels

Providing service via multiple channels such as Hot line, WeChat, WhatsApp, E-mail and official website to quickly take care of service requirements



### 24/7 response

24/7/365 available, quick response in 10 seconds



### One-stop service

Enjoy exclusive and professional service in the whole process of pre-sales, sales and after-sales



### Service channels

Hot line: +86 400-700-3278  
WeChat: 13923413428  
WhatsApp: 008613923413428  
Email: [service@absen.com](mailto:service@absen.com)  
Official website: [www.absen.com](http://www.absen.com)



### Service time (GMT+8)

8:30~24:00: Staff service  
00:00~8:30: Intelligent system service

## Absen service philosophy

### Initiative

Proactive care and return visits, regular touring inspection services for customers

### Efficiency

Absen customer service center responds within 10 seconds, intelligently match the best local service resources, and enjoy a fast service experience

### Standardization

Comprehensive service engineer training system, ACE professional training and certification, ACP professional certification; establishing customer's product files and record the entire service process

### Thoughtfulness

Longer warranty, worry-free quality





## Ready-to-Use LED

· Superior Quality / Worry-Free / Safe & Secure

## Superior Quality

Excellent product design

Reliable raw material

Standard manufacturing process

Quality control throughout the whole manufacturing process

Extraordinary visual effect



VS

---

## Inferior Quality

Crude product design

Poor raw material

Non-standard manufacturing process

No strict quality control

Terrible visual effect

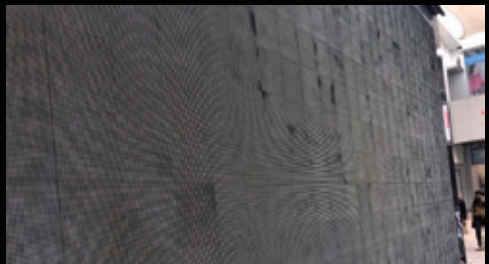

## On-Site Assembly LED

· Inferior Quality/ Troublesome/ Hidden Dangers

## Worry-Free

- Ready-to-use panel
- Quick installation
- One-stop standard solution
- Global service and long term warranty



## Safe & Secure

- Safe and trustworthy
- Certification
- Professional installation & maintenance services



## Troublesome

- On-site assembly
- Complicated installation
- Non-standard solution
- Unreliable after-sales service



## Hidden Dangers

- Great security risks
- No certification
- Non-standard installation & maintenance services



## Parameters

	KL1.2 II	KL1.5 II	KL1.8 II	KL2.5 II	
Physical parameters	LED type	Black SMD1010	Black SMD1212	Black SMD1515	Black SMD1515
	Pixel pitch (mm)	1.25	1.53	1.86	2.5
	Panel dimensions (W*H*D, mm)	640×360×65	640×360×65	640×360×65	640×360×65
	Panel resolution	512×288	416×234	344×192	256×144
	Panel weight (kg)	6	6	6	6
	Panel material	Die casting aluminum			
	Module size (W*H, mm)	320×180	320×180	320×180	320×180
Photoelectric parameters	Brightness (nit)	800	800	800	600
	Refresh rate (Hz)	≥3840	≥3840	≥3840	≥3840
	Grayscale (bit)	14	14	14	14
	Contrast ratio	4000:1	4000:1	4000:1	3000:1
	Color temperature (K)	2500-9500			
	Viewing angle (H/V, °)	140/120	160/140	160/140	160/140
	Drive mode	1/32	1/52	1/43	1/32
	AC operating voltage (V)	100~240	100~240	100~240	100~240
	Power consumption (max./avg., W/m <sup>2</sup> )	615/205	560/187	520/173	410/137
	Application parameters	Storage temperature (°C)	- 40~ + 60		
Operating temperature (°C)		- 10~ + 40			
Storage humidity (RH)		10%~85%			
Operating humidity (RH)		10%~80%			
IP rating (front/ rear)		IP40/IP21			
LED lifetime (h)		100000			
Panel maintenance type		Fully front			
Panel installation type		Stacking/ wall-mounting/ hanging			

\*Note: It is normal for the power consumption to fluctuate within  $\pm 15\%$  due to the influence of the brightness of different batches of lamps. Please refer to the actual situation.

★ Shenzhen Absen Optoelectronic Co., Ltd. reserves the right to modify product design, specifications, and parameters without further notice. Photos are used for illustration purpose only as products may differ from these photos. All rights reserved by Shenzhen Absen Optoelectronic Co., Ltd.

### Absen Optoelectronic Co.,Ltd

18-20F Building 3A, Cloud Park, Bantian Huawei Base,  
Longgang District Shenzhen, 518129, P.R.China  
T: +86-755-89747399 E: absen@absen.com  
F: +86-755-89747599 W: www.absen.com

### Absen Inc.

7120 Lake Ellenor Drive, Orlando,  
Florida 32809, USA  
T: +1-407-203-8870 E: info@usabsen.com  
F: +1-407-203-8873 W: www.usabsen.com

### Absen GmbH

Hessenring 4c, 64546 Moerfelden-Walldorf (Frankfurt am Main),  
Germany  
T: +49 (0) 6105 718941-0 E: europe@absen.com  
F: +49 (0) 6105 718941-29 W: www.absen-europe.com

